

## Ditec VIVAH

IP1776EN

Installation manual for control panel for automations with one or two 24V motors ≡

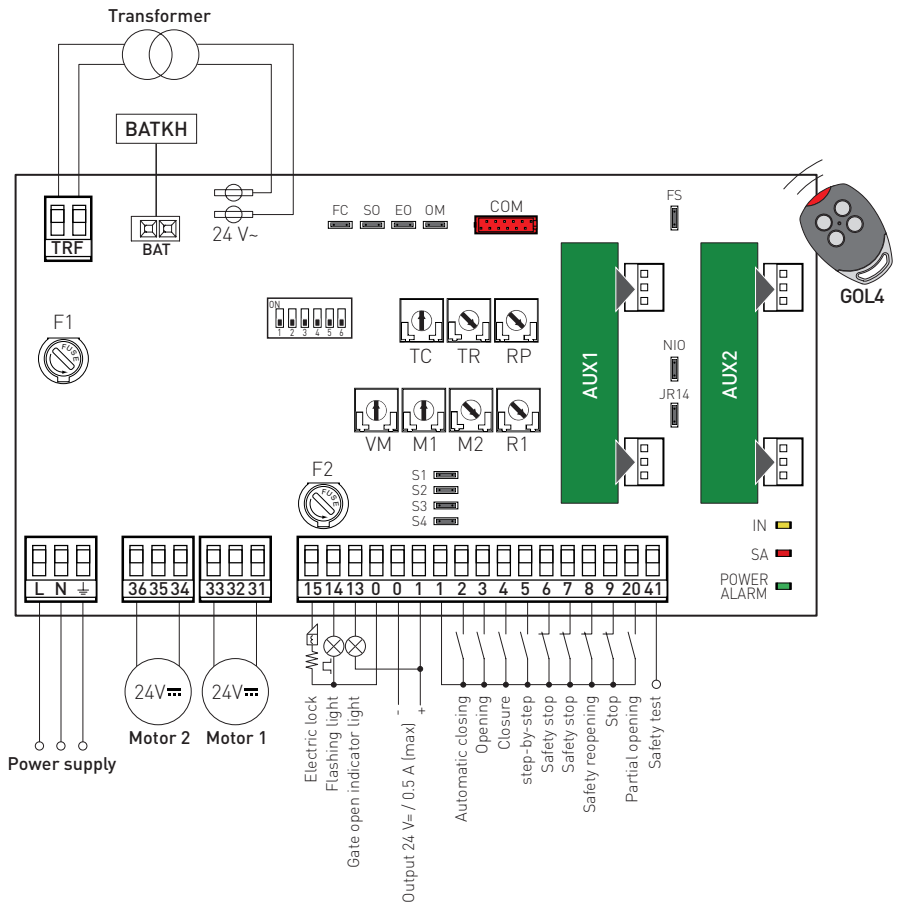

# Contents

	Subject	Page
1.	<b>General safety precautions</b>	25
2.	<b>EC Declaration of Conformity</b>	26
3.	<b>Technical specifications</b>	26
3.1	Applications	26
4.	<b>Commands</b>	27
4.1	Self-controlled safety edge	28
5.	<b>Outputs and accessories</b>	29
6.	<b>Adjustments</b>	30
6.1	Trimmer	30
6.2	Dip-switches	31
6.3	Jumper	31
6.4	Signals	32
6.5	Selection of automation type	32
7.	<b>Connection of motors</b>	33
8.	<b>Start-up</b>	34
9.	<b>Troubleshooting</b>	35
10.	<b>Example of application for automations with one motor</b>	36
11.	<b>Example of application for swing gates with two motors</b>	38
12.	<b>Example of application for parallel up-and-over doors</b>	40

## Key



This symbol indicates instructions or notes regarding safety, to which special attention must be paid.



This symbol indicates useful information for the correct functioning of the product.

All the rights concerning this material are the exclusive property of Entrematic Group AB. Although the contents of this publication have been drawn up with the greatest care, Entrematic Group AB cannot be held responsible in any way for any damage caused by mistakes or omissions. We reserve the right to make changes without prior notice. Copying, scanning and changing in any way are expressly forbidden unless authorised in writing by Entrematic Group AB.

# 1. General safety precautions



Failure to observe the information in this manual may lead to personal injury or damage to the equipment.

Keep these instructions for future reference

This installation manual is intended for qualified personnel only.

Installation, electrical connections and adjustments must be performed in accordance with Good Working Methods and in compliance with the present standards.

Read the instructions carefully before installing the product. Bad installation could be dangerous.



The packaging materials (plastic, polystyrene, etc.) should not be discarded in the environment or left within reach of children, as they are a potential source of danger.

Before installing the product, make sure it is in perfect condition.

Do not install the product in explosive areas and atmospheres: the presence of inflammable gas or fumes represents a serious safety hazard.

The safety devices (photocells, safety edges, emergency stops, etc.) must be installed taking into account: applicable laws and directives, Good Working Methods, installation premises, system operating logic and the forces developed by the automation.



Before connecting the power supply, make sure the plate data correspond to that of the mains power supply. An omnipolar disconnection switch with a contact opening distance of at least 3mm must be fitted on the mains supply.

Check that there is an adequate residual current circuit breaker and a suitable overcurrent cutout upstream of the electrical installation in accordance with Good Working Methods and with the laws in force.

When requested, connect the automation to an effective earthing system that complies with current safety standards.



During installation, maintenance and repair operations, cut off the power supply before opening the cover to access the electrical parts.

The electronic parts must be handled using earthed antistatic conductive arms. The manufacturer of the motorisation declines all responsibility if component parts not compatible with safe and correct operation are fitted.

Only use original spare parts for repairing or replacing products.

## 1.1 Installation precautions

Fix the control panel permanently. Pass the cables along from the lower side of the container.  
Before connecting the power supply, make sure the plate data correspond to that of the mains power supply.

An omnipolar disconnection switch with a contact opening distance of at least 3mm must be fitted on the mains supply.

Check there is an adequate residual current circuit breaker and overcurrent cutout upstream of the electrical system.

Use a FROR 450/750V 3x1.5 mm type electric cable and connect to the terminals L (brown), N (blue),  (yellow/green) in the automation.

Secure the cable using a special cable clamp.

Make sure there are no sharp edges that may damage the power supply cable.

Connection to the mains power supply, in the section outside the automation, is made with independent channel and separated from the connections to the control and safety devices.

## 2. EC Declaration of Conformity

The manufacturer Entrematic Group AB, with headquarters in Lodjursgatan 10, SE-261 44 Landskrona, Sweden, declares that the Ditec VIVAH control panel complies with the conditions of the following EC directives:

EMC Directive 2004/108/EC



Low Voltage Directive 2006/95/EC.

Landskrona, 01-07-2014

Marco Pietro Zini  
President & CEO



## 3. Technical specifications

<b>Power supply</b>	230V~ / 50-60 Hz
<b>F1 fuse</b>	F2A
<b>F2 fuse</b>	F2.5A
<b>Motor output</b>	24 V  / 2 x 12 A max
<b>Power supply for accessories</b>	24 V  / 0,5 A
<b>Temperature</b>	-20 °C / +55 °C
<b>Degree of protection</b>	IP55
<b>Container dimensions</b>	238x357x120



NB: The given operating and performance features can only be guaranteed with the use of DITEC Entrematic accessories and safety devices.

### 3.1 Applications

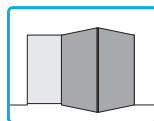
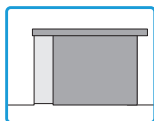
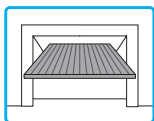
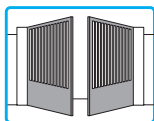
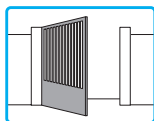





## 4. Commands



Command	Function	Description
1 — 2	NO AUTOMATIC CLOSING	Permanently closing the contact enables automatic closing.
1 — 3	NO OPENING	Contact closure activates the opening operation.
1 — 4	NO CLOSING	Contact closure activates the closing operation.
1 — 5	NO STEP-BY-STEP	Contact closure activates a sequential opening and closing operation: opening-stop-closing-opening. NB: if automatic closing is enabled, the stop is not permanent but has a duration set with the TC trimmer.
1 — 6	NC OPENING SAFETY DEVICE	Opening the safety contact stops the opening operation in progress and prevents future opening operations.
1 — 7	NC CLOSING SAFETY DEVICE	Opening the safety contact stops the closing operation in progress and prevents future closing operations.
1 — 6 7	NC SAFETY STOP	The opening of the safety contact stops and prevents any movement. NB: It does not carry out the disengagement operation. WARNING: only use with photocells installed.
1 — 8	NC REVERSAL SAFETY CONTACT	Opening the safety contact triggers a reversal of the movement (reopening) during the closing operation. With SO=ON with the automation stopped, the opening of the contact prevents any operation. With SO=OFF with the automation stopped, the opening of the contact only prevents the closing operation.
1 — 9	NC STOP	Opening the safety contact stops the current operation.
	EMERGENCY STOP	Connect the opening and closing controls to terminal 9 instead of terminal 1 (9-3, 9-4, 9-20).
1 — 9	NO COMMAND WITH OPERATOR PRESENT	Opening of contact 1-9 enables the operator present function: - opening with operator present 1-3; - closing with operator present 1-4. NB: any safety devices, automatic closing and plug-in cards in the AUX1 and AUX2 housings are disabled.
1 — 20	NO PARTIAL OPENING	Contact closure activates a partial opening operation of motor 1 (M1) of the duration set with the RP trimmer. Once the automation stops, the partial opening control performs the opposite operation to the one performed before the stop. NB: if automatic closing is enabled, the stop is not permanent but has a duration set with the TC trimmer.



## 4.1 SOFA1-SOFA2 or GOPAVRS self-controlled safety edge



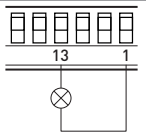
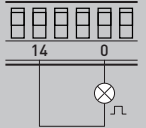
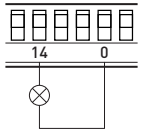
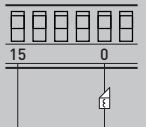
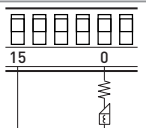

Command		Function	Description
 <p>SOFA1-SOFA2 GOPAV</p>		SAFETY TEST	Place the SOFA1-SOFA2 device into the special housing for plug-in cards AUX1 or AUX2. With JR14=OFF, connecting terminal 41 enables a safety edge test cycle before every operation. If the test fails the SA LED flashes and the test is repeated.
1	 6	NC	OPENING SAFETY DEVICE
1	 7	NC	CLOSING SAFETY DEVICE
1	 8	NC	REVERSAL SAFETY CONTACT

## 5. Outputs and accessories

Output	Value / Accessories	Description
	24 V $\overline{\sim}$ 0.5 A	<b>Accessories power supply.</b> Power supply output for external accessories, including automation status lamps. NB: the maximum absorption of 0.5 A corresponds to the sum of all terminals 1.
	24 V $\overline{\sim}$ / 3 W	<b>Automation status lamp (proportional).</b> The light goes off when the automation is closed; the light comes on when the automation is open; The light flashes with a variable frequency while the automation is operating.
	LAMPH 24 V $\overline{\sim}$ / 25 W	<b>Flashing light.</b> With DIP6=OFF it is activated during the opening and closing operations. Output protected by fuse F2.
	24 V $\overline{\sim}$ / 25 W	<b>Courtesy light.</b> With DIP6A=ON a courtesy light that turns on for 180 seconds with every opening (total or partial), step-by-step and closing command can be connected. Output protected by fuse F2.
	24 V $\overline{\sim}$ / 300 mA	<b>Electric block.</b> It is activated when the automation is closed. Output protected by fuse F2.
	12 V $\sim$ / 15 W	<b>Electric lock.</b> Connect the supplied 8.2 $\Omega$ / 5W resistance in series. Output protected by fuse F2.
AUX1 AUX2		The control panel is fitted with two housings for plug-in cards such as radio receivers, magnetic loops, etc. Operating of the plug-in cards is selected using DIP1. <b>WARNING:</b> the plug-in cards must be inserted and removed with the power supply disconnected.
COM		DO NOT USE
	BATKH 2x12 V 2 Ah	<b>BAT - Battery-powered operation.</b> The batteries are kept charged when the power supply is on. If the power supply is off, the panel is powered by the batteries until the power is re-establish or until the battery voltage drops below the safety threshold. The panel turns off in the last case. <b>WARNING:</b> the batteries must always be connected to the control panel for charging. Periodically check the efficiency of the batteries. NB: the operating temperature of the rechargeable batteries is from +5°C to +40°C.
	BATK2 2x12 V 6.5 Ah	

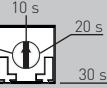

# 6. Adjustments

## 6.1 Trimmers



Trimmer	Description
<b>TC</b> 	<p><b>Setting automatic closing time. From 0 to 120 s (with 1-2 closed).</b></p> <p>The count begins from the blocking of the automation, for the time set by the TC.</p> <p>With DIP2=OFF, once a safety switch has been activated, the counter starts as soon as the safety switch is released (for example, after passing through the photocells), and lasts for a period of time set with TC.</p> <p>With DIP2=ON, the counter starts when automation is opened and lasts for the entire duration set with TC.</p> <p>With contact 1-2 open or 1-9 open, automatic closing is disabled. When 1-2 is closed, automatic closing is enabled once more. If disabled from 1-9, automatic closing is enabled once more, once contact 1-9 has been reclosed, only after a total, partial or step-by-step opening command.</p>
<b>TR</b> 	<p><b>Setting motor 1 (M1) closing delay time. From 0 to 30 s.</b></p> <p>When closing, motor 1 (M1) arrives with a delay set with trimmer TR compared with motor 2 (M2).</p> <p>When opening, motor 2 (M2) starts with a delay of 3 s compared with motor 1 (M1). If TR=MIN, the door wings start simultaneously.</p> <p>NB: we recommend setting TR=MIN with non-overlapping door wings and setting TR&gt;3 s with overlapping door wings.</p>
<b>RP</b> 	<p><b>Setting motor 1 (M1) partial opening.</b></p> <p>Adjust the percentage of partial opening of motor 1 (M1) from 10% to 100% of the total operation.</p>
<b>VM</b> 	<p><b>Operation speed adjustment.</b></p> <p>Adjusts the automation operation speed.</p> <p>The closing speed is the same as the opening speed.</p>
<b>M1 / M2</b> 	<p><b>Setting motor 1 (M1) operation time. from 5 s to 30 s.</b></p> <p>Setting motor 2 (M2) operation time. From 5 s to 30 s.</p> <p>(or from 5 s to 45 s depending on the settings in paragraph 6.5).</p> <p>The opening/closing operation is shown in chapters 11, 12 and 13: the operation consists of a part with the speed set with trimmer VM, the duration set with trimmer M1/M2 and deceleration to a fixed speed when both opening and closing.</p> <p>When opening, this deceleration lasts a maximum of 10 s and when closing, it lasts until the mechanical stop or a stop limit switch is reached (with FC=OFF).</p>
<b>R1</b> 	<p><b>Power setting.</b></p> <p>The control panel is fitted with a safety device which, when it detects an obstacle:</p> <ul style="list-style-type: none"> <li>- during opening, stops movement with a disengagement operation;</li> <li>- during closing, before deceleration, inverts movement;</li> <li>- during closing, during deceleration with FC=ON, stops movement and with FC=OFF inverts movement.</li> </ul>









## 6.2 Dip-switches

DIPs	Description	OFF 	ON 
DIP1	Plug-in card operation. NB: also sets operating of the plug-in cards connected on AUX1 and AUX2.	Step-by-step.	Opening.
DIP2	Automatic closing time restore.	50%	100%
DIP3	Automation status at power on. Indicates how the control panel considers automation when powered up.	Open.	Closed. NB: if the automatic closing function is not used, we recommend setting DIP3=ON.
DIP4	Electric lock release.	Disabled.	Enabled. NB: when the electric lock is installed, set DIP4=ON.
	(DOKE) Electric block function. NB: only with EO=OFF.	Powered for the entire opening and closing operation.	Powered only with the automation closed.
DIP5	Preflashing for 3 seconds.	Disabled during opening. Enabled only with automatic closing with TC >3 s.	Enabled for both opening and closing.
DIP6	Operating of output 0-14.	Flashing light.	Courtesy light.







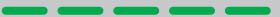













































## 6.3 Jumpers

Jumper	Description	OFF 	ON 
FC	Selection of limit switch mode.	Stop limit switch.	Deceleration limit switch.
S0	Reversal safety contact operation.	With automation stopped and contact 1-8 open, opening operations are permitted.	With automation stopped and 1-8 open, all operations are disabled.
EO	Electric lock function.	powered for 2,5 s at the beginning of the opening operation.	Powered for 1.2 s at the beginning of the opening operation.
OM	Automation type.	Automation with 1 or 2 parallel motors.	Automation with 2 independent motors.
FS	Selection of LUX05BH automation start voltage. 	Always 12 V	6 V with NIO enabled (OFF) and high ambient temperature. 12 V with NIO enabled (OFF) and very low ambient temperature.
NIO	Electronic antifreeze system. Maintains motor efficiency even at low ambient temperatures.	Enabled.	Disabled.
JR14	Safety test terminal 41.	Enabled.	Disabled.

## 6.4 Signals

LED	On	Flashing light
<b>IN</b> 	Command received or change in status of a dip-switch.	/
<b>SA</b> 	At least one of the safety contacts is open.	<p> Safety test failure (terminal 41).</p> <p>Operations count performed (only when control panel is switched on):</p> <p> = 1000 operations</p> <p> = 10000 operations</p>
<b>POWER ALARM</b> 	Power supply on.	<p> Incorrect selection of type of automation (jumper S1, S2, S3, S4). NB: the signal lasts 10 s after which the control panel is automatically reset.</p> <p> Absence of motor or incorrect selection of jumper OM. NB: the signal lasts 10 s after which the control panel is automatically reset.</p>

## 6.5 Selection of automation type

Automation type	S1	S2	S3	S4
Factory settings				
OBBI3BH, ARCBH				
CUBIC30H, CUBIC6H				
CUBIC30H+CUBIC30LI, CUBIC6H+CUBIC6TC CUBIC6H+CUBIC6TIG				
BOX3SH				
ARC1BH, DOR1BH (recommended dimensions)				
ARC1BH (limit dimensions)				
DOR1BH (limit dimensions)				
FACIL3H				
DOKE				
LUX03BH, LUX04BH				
LUX05BH (recommended dimensions)				
LUX05BH (limit dimensions)				

## 7. Connection of motors

Motor <b>2</b>	Electrical panel terminal board	
	34	36
OBBI3BH	Black	Blue
ARCBH ARC1BH	Black	Blue
CUBIC30H	Black	Blue
CUBIC6H CUBIC6HV	Black	Blue
LUX03BH LUX04BH LUX05BH	31/34	33/36
FACIL3H	Blue	Black

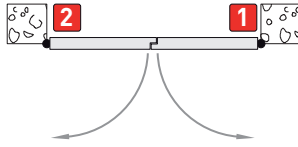

Motor <b>1</b>	Electrical panel terminal board	
	31	33
OBBI3BH	Blue	Black
ARCBH ARC1BH	Blue	Black
CUBIC30H	Blue	Black
CUBIC6H CUBIC6HV	Blue	Black
LUX03BH LUX04BH LUX05BH	31/34	33/36
FACIL3H	Black	Blue

Motor <b>1</b>	Electrical panel terminal board	
	31	33
OBBI3BH	Black	Blue
ARCBH ARC1BH	Black	Blue
CUBIC30H	Black	Blue
CUBIC6H CUBIC6HV	Black	Blue
LUX03BH LUX04BH LUX05BH	31/34	33/36
FACIL3H	Blue	Black

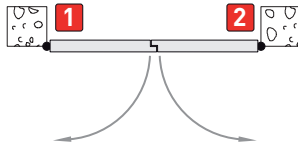

Motor <b>2</b>	Electrical panel terminal board	
	34	36
OBBI3BH	Blue	Black
ARCBH ARC1BH	Blue	Black
CUBIC30H	Blue	Black
CUBIC6H CUBIC6HV	Blue	Black
LUX03BH LUX04BH LUX05BH	31/34	33/36
FACIL3H	Black	Blue

## 8. Start-up



The operations in point 4 are performed without safety devices.

The trimmers can only be adjusted with the automation idle.

After start-up the control panel receives a RESET and the first operation is performed at reduced speed [automation position acquisition], one wing at a time (first motor M2 and then motor M1).

- 1- Make a jumper for NC safety contacts.
- 2- Check the type of application selected. Select the type of automation with jumpers S1, S2, S3 and S4 as indicated on page 32.
- 3- Adjust the opening and closing stop limit switches, if any.  
NB: limit switches must be kept pressed until the operation has been completed.
- 4- Set TC=MAX and R1=MAX.  
Set TR=MIN or TR>3 s with automations with 2 overlapping door wings.
- 5- Switch on and check the automation is operating correctly with the subsequent opening and closing commands.  
Check that the limit switches are activated if used.  
NB: if the direction of rotation of the motor does not correspond to the correct direction of movement of the automation, reverse the power supply polarity 31-33 or 34-36.
- 6- If used, adjust the deceleration limit switches during opening and closing and set M1=MAX and M2=MAX.  
Adjust trimmer VM and check the opening speed and closing speed.  
NB: if the wings reach the mechanical stops too quickly, advance limit switch intervention.
- 7- If the limit switches are not used:
  - set M1=50%, M2=50% and VM=50%;
  - check the automation is operating correctly with a series of opening and closing commands;  
WARNING: wait for the operation to complete before giving the next command.
  - adjust the operation time using trimmers M1 and M2 so that the wings approach the mechanical stops slowly. We recommend setting a deceleration time that guarantees completion of the operation even in the presence of friction or other adverse environmental factors (wind, ice, etc.).
- 8- Connect the safety devices (removing the relative jumpers) and check they function correctly.
- 9- If desired, adjust the delay time during closing of motor 1 (M1) with trimmer TR.
- 10- If desired, adjust the automatic closing time with the TC trimmer.  
WARNING: the automatic closing time after a safety is activated depends on the DIP2 setting.
- 11- Set the obstacle thrust with the R1 trimmer.  
NB: if the second door wing to close encounters an obstacle during the operation, both door wings reopen and the subsequent closing operation is performed one door wing at a time.  
WARNING: Ensure that the forces exerted by the door wings are compliant with EN12453-EN12445 regulations.
- 12- If desired, adjust the partial opening of motor 1 (M1) with trimmer RP.
- 13- If desired, connect the radio receiver by placing it in the housing for plug-in cards AUX1 or AUX2 and program the remote controls as indicated in the installation manual.
- 14- Connect any other accessories and check they are functioning.
- 15- Once the start-up and check procedures are completed, close the container.



NB: in the event of servicing or if the control panel is to be replaced, repeat the start-up procedure.

## 9. Troubleshooting

Problem	Possible cause	Operation
The automation does not open or close.	No power. (POWER ALARM LED off).	Check the control panel is powered correctly.
	Short circuited accessories. (POWER ALARM LED off).	Disconnect all accessories from terminals 0-1 (a voltage of 24V= must be present) and reconnect them one at a time.
	Blown line fuse. (POWER ALARM LED off).	Replace fuse F1.
	Safety contacts are open. (SA LED on).	Check that the safety contacts are closed correctly (INC).
	Motor(s) not connected. (flashing POWER ALARM LED).	Check correct connection of motor(s). Check the setting of jumper OM.
	Incorrect selection of automation type. (flashing POWER ALARM LED).	Check that jumpers S1, S2, S3 and S4 have been selected correctly.
	Safety contacts not correctly connected or self-controlled safety edge not functioning correctly. (flashing SA LED).	Check connections to terminals 6-7-8 on the control panel and connections to the self-controlled safety edge.
	The opening and closing commands do not work.	Check that IN LED comes on with each opening and closing command.
	Incorrect setting of jumper JR14.	Check the safety contact connections.
	Photocells activated. (SA LED on).	Check that the photocells are clean and operating correctly.
The automatic closing does not work.		Check that the TC trimmer is not set at the maximum.
		Check that contact 1-2 is closed.
The external safety devices are not activated.	Incorrect connections between the photocells and the control panel.	Connect NC safety contacts together in series and remove any jumpers on the control panel terminal board.
The automation reopens by itself, from the closing stop.	Limit switch not working. (SA and IN LEDs flashing).	Make sure the limit switches are working correctly.
The flashing light is not working.	Fuse F2 burnt out.	Replace fuse F2.
The electric lock is not working.		
The remote control has limited range and does not work with the automation moving.	The radio transmission is impeded by metal structures and reinforced concrete walls.	Install the antenna outside.
		Replace the transmitter batteries.

# 10. Example of application for automations with one motor.

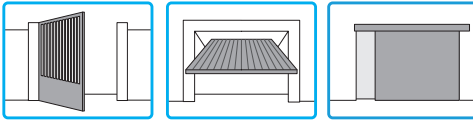

When the control panel is used in applications for automations with one swinging door wing, for up-and-over doors or for sliding doors, these connections can be made:

(Fig. 10.1) Use without limit switches.  
Set OM=OFF.

Connect the motor as indicated in the figure.  
NB: during the opening operation the polarities are the ones indicated in the figure.  
Set VM to the desired speed.  
Set M1 so that the door wing slows down before reaching the mechanical stop.

In this configuration, the door wing stops when it reaches the mechanical opening and closing stop.  
When the time set with M1 expires:

- during opening, the deceleration time lasts a maximum of 10 s;
- during closing, the door wing slows down until it reaches the mechanical stop.

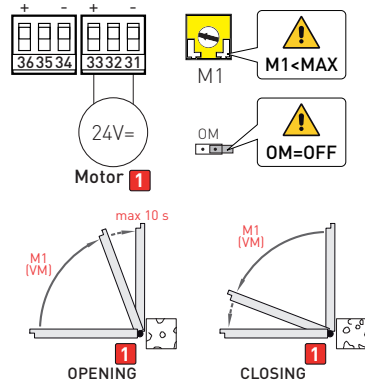

(Fig. 10.2) Use with deceleration limit switch.  
Set OM=OFF.

Connect the motor and deceleration limit switches as indicated in the figure:  
• [A] deceleration limit switch during opening;  
• [C] deceleration limit switch during closing.  
Set VM to the desired speed. Set M1=MAX.

In this configuration, the door wing stops when it reaches the mechanical opening and closing stop.  
After activation of the deceleration limit switch during opening and closing, the deceleration time lasts a maximum of 10 s.

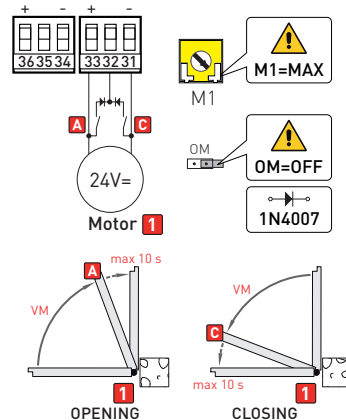

(Fig. 10.3) Use with stop limit switch.

Set OM=OFF and FC=OFF.

Connect the motor and stop limit switches as indicated in the figure:

- [A] stop limit switch during opening;
- [C] stop limit switch during closing.

NB: a single limit switch can also be installed.

Set M1<MAX.

Set VM to the desired speed.

Set M1 so that the door wing slows down before the limit switch is activated.

With this configuration, the door wing stops when the limit switch is activated.

When the time set with M1 expires:

- during opening, the deceleration time lasts a maximum of 10 s;
- during closing, the door wing slows down until it reaches the stop limit switch.

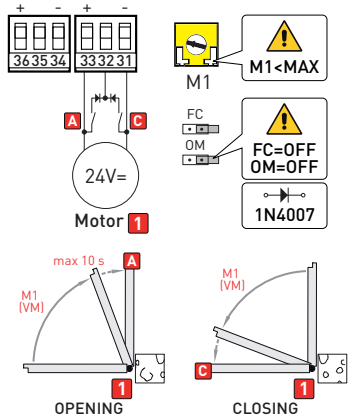

# 11. Example of application for swing gates with two motors

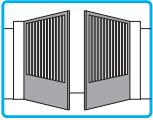

When the control panel is used in applications for automations with two swinging door wings, these connections can be made:

(Fig. 11.1) Use without limit switches.  
 Connect the motors as indicated in the figure.  
 NB: during the opening operation the polarities are the ones indicated in the figure.  
 Set VM to the desired speed.  
 Set M1 and M2 so that the door wings slow down before they reach the mechanical stops.  
 In this configuration, each door wing stops when it reaches the mechanical opening and closing stop.

When the time set with M1-M2 expires:

- during opening, the deceleration time lasts a maximum of 10 s;
- during closing, the door wings slow down until they reach the mechanical stop.

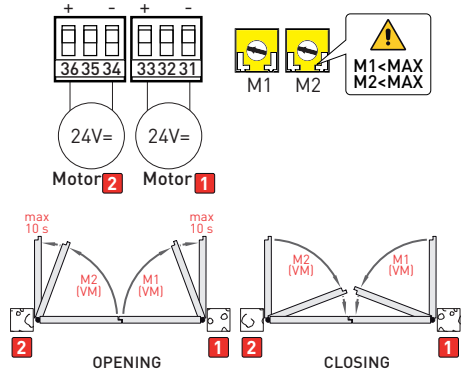

(Fig. 11.2) Use with deceleration limit switch.  
 Connect the motors and deceleration limit switches as indicated in the figure:

- [A] deceleration limit switch during opening;
- [C] deceleration limit switch during closing.

Set M1=MAX and M2=MAX.  
 Set VM to the desired speed.  
 In this configuration, each door wing stops when it reaches the mechanical opening and closing stop.  
 After activation of the deceleration limit switches during opening and closing, the deceleration time lasts a maximum of 10 s.

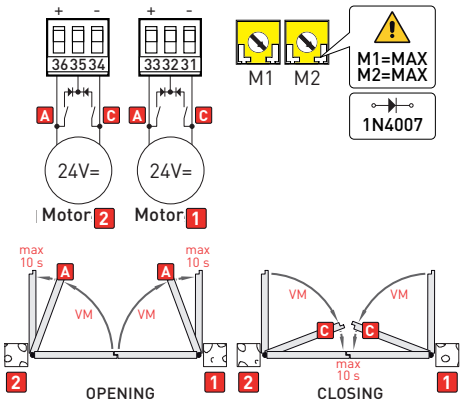



(Fig. 11.3) Use with stop limit switch.

Set FC=OFF.

Connect the motors and stop limit switches as indicated in the figure:

- [A] stop limit switch during opening;
- [C] stop limit switch during closing.

NB: a single limit switch can be installed for each motor.

Set M1<MAX and M2<MAX.

Set VM to the desired speed.

Set M1 and M2 so that the door wing slows down before the limit switches are activated.

With this configuration, each door wing stops when the relative limit switch is activated.

When the time set with M1-M2 expires:

- during opening, the deceleration time lasts a maximum of 10 s;
- during closing, the door wings slow down until they reach the stop limit switch.

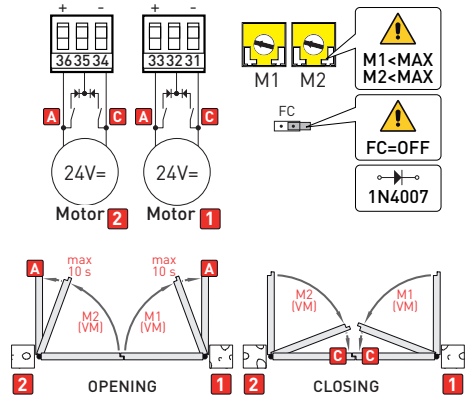

## 12. Example of application for parallel up-and-over doors with two motors

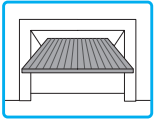

When the control panel is used in applications for automations with up-and-over doors with two parallel motors, these connections can be made:

(Fig. 12.1) Use without limit switches.

Set OM=OFF.

Connect the motors as indicated in the figure.

NB: during the opening operation the polarities are the ones indicated in the figure.

Set VM to the desired speed.

Set M1 so that the door wing slows down before reaching the mechanical stop.

In this configuration, the door wing stops when it reaches the mechanical opening and closing stop.

When the time set with M1 expires:

- during opening, the deceleration time lasts a maximum of 10 s;
- during closing, the door wing slows down until it reaches the mechanical stop.

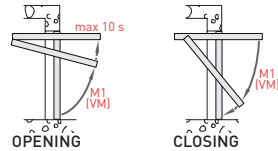
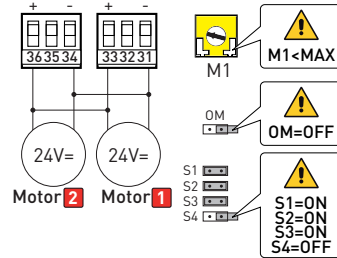

(Fig. 12.2) Use with deceleration limit switch.

Set OM=OFF.

Connect the motors and deceleration limit switches as indicated in the figure:

- [A] deceleration limit switch during opening;
- [C] deceleration limit switch during closing.

Set M1=MAX.

Set VM to the desired speed.

In this configuration, the door wing stops when it reaches the mechanical opening and closing stop.

After activation of the deceleration limit switch during opening and closing, the deceleration time lasts a maximum of 10 s.

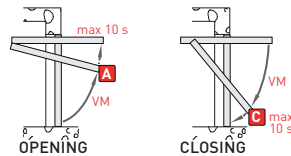
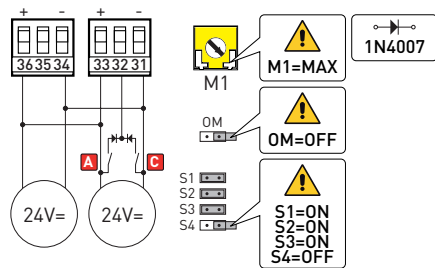

(Fig. 12.3) Use with stop limit switch.

Set OM=OFF and FC=OFF.

Connect the motors and stop limit switches as indicated in the figure:

- [A] stop limit switch during opening;
- [C] stop limit switch during closing.

NB: a single limit switch can also be installed.

Set M1<MAX.

Set VM to the desired speed.

Set M1 so that the door wing slows down before the limit switch is activated.

With this configuration, the door wing stops when the limit switch is activated.

When the time set with M1 expires:

- during opening, the deceleration time lasts a maximum of 10 s;
- during closing, the door wing slows down until it reaches the stop limit switch.

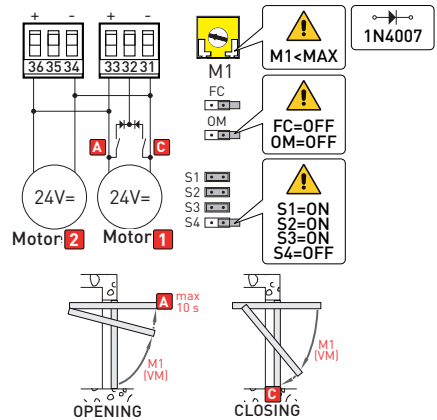

---

# ENTRE//MATIC



**Entrematic Group AB**  
Lodjursgatan 10  
SE-261 44, Landskrona  
Sweden  
[www.ditecentrematic.com](http://www.ditecentrematic.com)

